

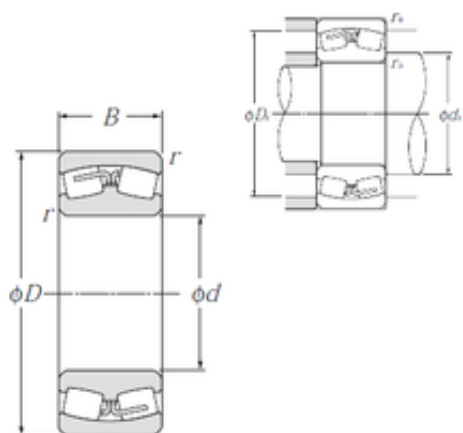

UIN BEARING CORP.

231/750B NTN Spherical Roller Bearings



Bearing No. 231/750B

Size	750x1220x365 mm
Bore Diameter	750 mm
Outer Diameter	1220 mm
Width	365 mm
d	750 mm
D	1 220 mm
B	365 mm
C	365 mm
r min.	9,5 mm
da min.	794 mm
Da max.	1 176 mm
ra max.	8 mm
Weight	1 700 Kg
Basic dynamic load rating (C)	12 800 kN
Basic static load rating (C0)	27 200 kN
(Grease) Lubrication Speed	200 r/min
(Oil) Lubrication Speed	260 r/min
Calculation factor (e)	0,29
Calculation factor (Y0)	2,27
Calculation factor (Y1)	2,32

231/750B Bearing 2D drawings and 3D CAD models